



Cover 1:
Cove Hazel

Cover 2:
Odelle Rust

Cover 1:
Cove Natural

Walnut Feet

Miller Collection

Colours represented are to be used as a guide only.
Please refer to manufacturers swatch for a more accurate colour match.

Please note that colour shadings can vary slightly from each roll of fabric.
We cannot guarantee a precise match to these samples or between cut lengths and upholstered goods.

27/02/2023

MILLER COVER GUIDE: STANDARD BACK ONLY

Please use this guide when ordering the following pieces to clarify cover options.

3 Seater Sofa (3ST)

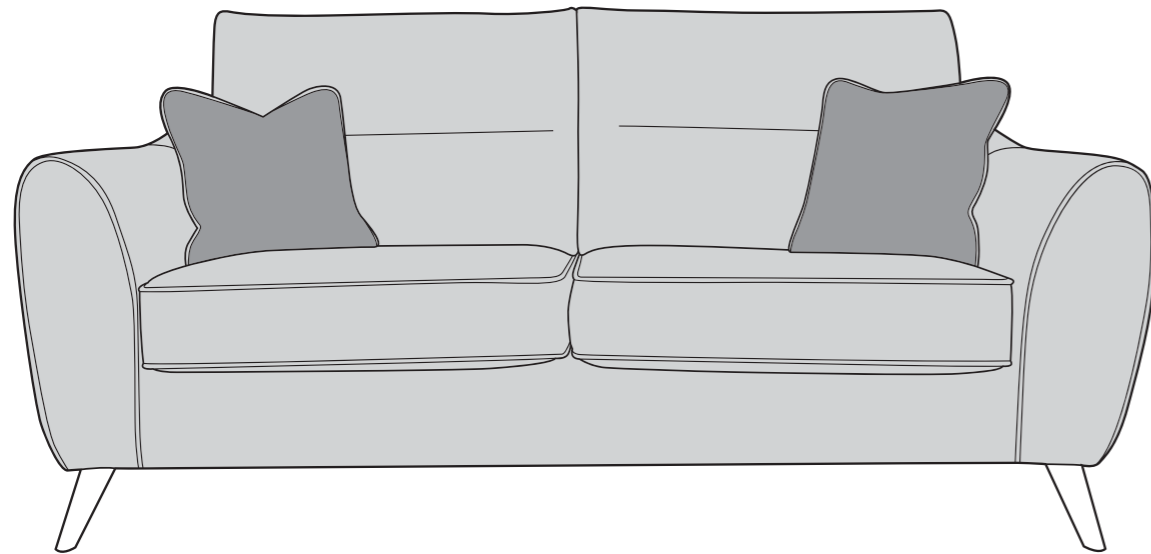

2 Seater Sofa (2ST)

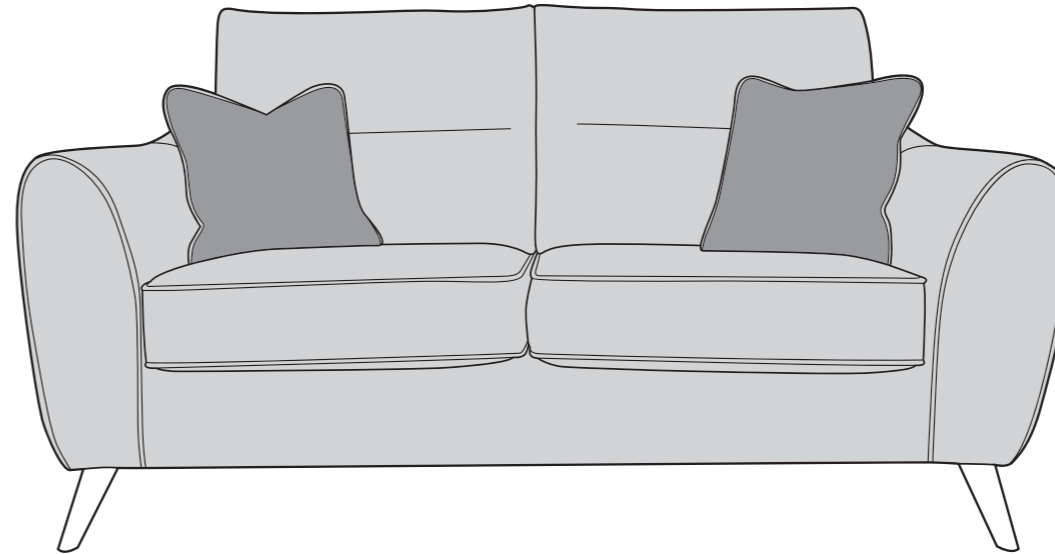

Armchair (1ST)

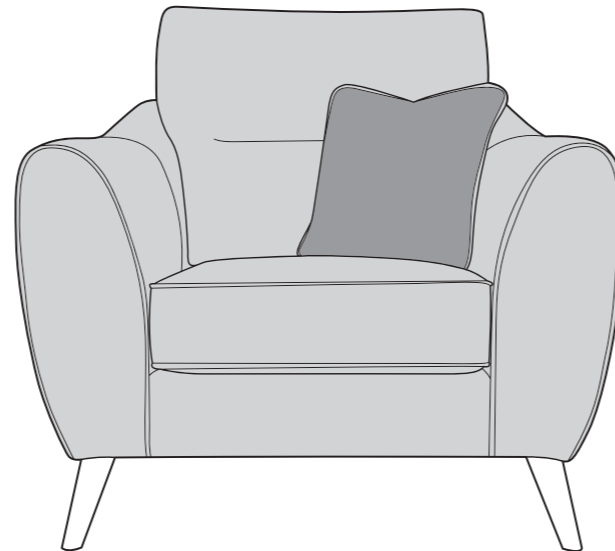

-  **COVER 1**
(BODY)
-  **COVER 2**
(SCATTER)

Scatter Cushions

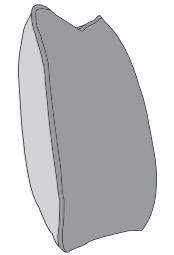

Piped Edge
Front = Cover 2
Back = Cover 1

SUGGESTED ACCENT PIECES

Miller Footstool (FST)

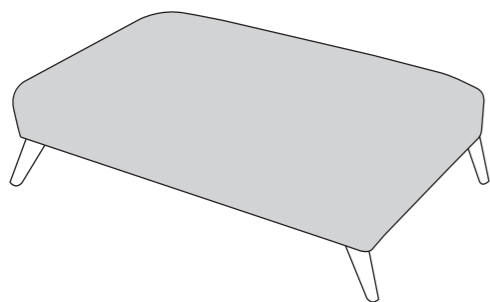

MILLER DIMENSIONS (CM)

AVAILABLE PIECES	HEIGHT 1	WIDTH 2	DEPTH 3	SEAT HEIGHT 4	SEAT DEPTH 5	SEAT WIDTH 6	ACCESS DIAGONAL 7	OUTBACK HEIGHT 8	ARM HEIGHT 9	WEIGHT (KG)	SCATTER CUSHION NO.
3 SEATER SOFA (3ST)	99	206	100	50	55	161	220	83	71	57	2
2 SEATER SOFA (2ST)	99	182	100	50	55	137	197	83	71	49	2
ARMCHAIR (1ST)	99	84	100	50	55	59	136	83	71	36.5	1
ACCENT PIECE											
MILLER FOOTSTOOL (FST)	35	106	65	N/A	N/A	N/A	N/A	N/A	N/A	14.5	N/A

* Hardwood & composite board frame.

* Dowelled, screwed, glued & stapled joinery.

* Walnut and Mid Oak foot options.

* Fibre back cushions for added comfort.

* Reversible high density foam seats for support & comfort.

* Feather filled scatters included. 

* Serpentine seat springs & silent wire.

* Elasticated back webbing.

DIMENSION GUIDE

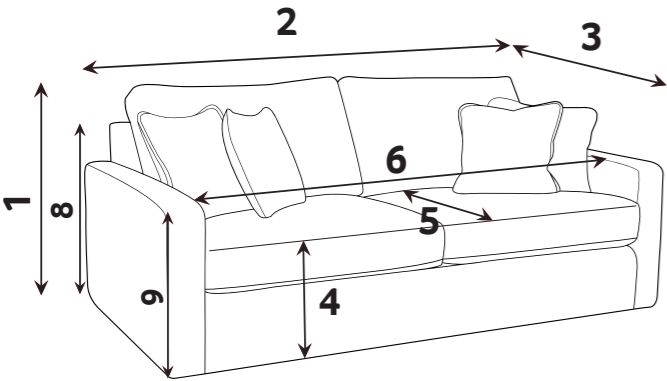

Check the diagonal access dimension to ensure furniture will fit in your home.

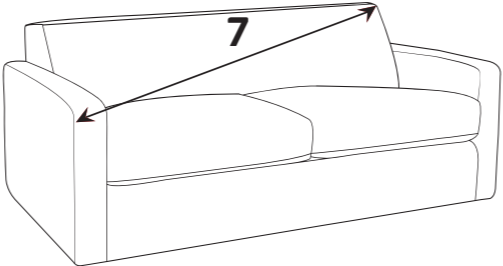

- 1 - HEIGHT
- 3 - DEPTH
- 5 - SEAT DEPTH (STD & PILLOW)
- 7 - DIAGONAL ACCESS
- 2 - WIDTH
- 4 - SEAT HEIGHT
- 6 - SEAT WIDTH
- 8 - OUTBACK HEIGHT
- 9 - ARM HEIGHT

Illustrations used for reference only.

REVERSIBLE HIGH DENSITY FOAM SEATS

Our high density foam seat interiors offer a comfortable and supportive sit whilst maintaining their shape.

CARE GUIDE

To improve the longevity of your hand-made furniture, we recommend rotating cushions (where applicable).

For further information on maintaining your furniture, please refer to the Care Guide located under the seat platform.

Walnut



Mid Oak



FOOT OPTIONS:

Wood is a natural product and will vary in shade/colour from item to item. Feet may require fitting.

Please note : All dimension are approximate. Allow tolerance of +/- 2.5cm.

